



Head Solutions



STEALTH PRODUCTS, INC.
BEYOND EXPECTATION

2015 - 2016



TABLE OF CONTENTS

IN THIS SECTION...

HEAD SUPPORT 4	HEAD POSITIONING 16
Comfort Plus Series 4	Stealth Ultra Series 16
The name says it all! When it comes to posterior head support, the Comfort Series is a must! Luxurious comfort with plush foam construction and sleek design make the Comfort Plus a favorite.	The "Ultra" head positioning system was the first product Stealth designed. Its advanced technology continues to evolve from the Ultra, to the Ultra QCR, and now the Ultra QCRS; pioneering the new standard of head positioning.
Tri Comfort Plus Series 6	Building an Ultra 17
The Tri Comfort Plus Series has all of the benefits of the Comfort Plus Series in terms of comfort, luxury and style. What makes this headrest different is its three surfaces providing moderate lateral support. So don't settle for less, choose our Tri Comfort Plus and increase your level of comfort today!	Clinical Guidelines 18
Adjustable Comfort Plus 8	What makes the SU the best?..... 19
With two individually adjustable side pads offering 45° of angle adjustment, this headrest was designed for individuals with low tone or minimal head support. It also helps in discouraging lateral flexion for those individuals who have a tendency to hook around their head supports.	i2i Series 20
Contoured Series 10	The i2i has been one of Stealth's signature products and one that is recognized around the world. The i2i head, neck, and shoulder positioning system is offered in eleven different series. We have made significant improvements through the years and now have added a few more.
Whether used as a stand alone posterior head support or as part of a larger system, the Contoured Series molded headrests are ergonomically formed and valued for their robust performance and economical price.	Real Results! 21
All Positioning Series 12	i2i Overview 22
When you need comfort and adjustability, depend on our All Positioning headrest. The AP Series offers a unique flexibility, constructed of malleable metal allowing a shape-on-demand quality, yet strong enough to retain its shape. When formed around the individual's head it is virtually invisible.	SWING-AWAY SYSTEMS 24
Combo Series 14	With the addition of Stealth's swing-away hardware, you can upgrade a simple posterior head support into a head positioning system. Stealth's swing-away hardware is designed to be reliable, lightweight, clean, and discreet so that the hardware blends in with its surrounding so "you see the person, not the hardware!" It features an easy one-hand release mechanism, enabling pads and switches to swing away back 100°, and just as easily return to their original position. This convenient feature is useful for transfers, therapy, and fatigue issues. It's no wonder why Stealth Products has moved to the "HEAD OF THE CLASS."
The Combo Series is a posterior head support that features three individual pads with adjustable wings. The lateral pads were designed to provide a wide degree of angle adjustment for optimal contact and support.	Swing-Away Layout Options..... 25
	FOAM AND UPHOLSTERY 26
	MOUNTING HARDWARE..... 27
	Straight Hardware 27
	Link Style Hardware..... 27
	Extras..... 27



THIS IS A QR CODE, SCAN WITH YOUR MOBILE DEVICE CAMERA* OR CLICK TO FOLLOW URL LINK ANYTIME YOU SEE ONE.



Head Support vs. Head Positioning

When Stealth Products was first introduced to the market back in 1999, the only product produced was a sophisticated head positioning system well ahead of its years, the Ultra OCR. In the world of complex rehab, each individual presents their own unique challenges for support and positioning due to the vast number of diagnosis's and injuries. Over the years Stealth Products has upgraded and added to its arsenal key products to help support individuals with this battle. With a wide range of products designed to solve any control or positioning puzzle, Stealth Products has distinguished itself from the rest of the pack as the leader in posterior head support and positioning.

Head Support Systems

Posterior head supports are designed to cradle the head and are primarily used as a resting spot with nominal lateral support. Stealth Products offers a variety of posterior head supports at an affordable price!



Pg 4
Comfort Plus Series*



Pg 6
Tri Comfort Plus Series*



Pg 8
Adjustable Comfort Plus Series*



Pg 12
All Positioning Series*



Pg 14
Combo Series*



Pg 10
Contoured Series*

Individuals who:

- require minimal to no support
- are able to maintain a neutral head position
- have a mobility base with tilt (recline)



Compatible with **DRIVE**



Head Positioning Systems

Head, neck, and shoulder positioning can be one of the most difficult challenges we face. Stealth Products offers an array of products to solve these most difficult needs. With our intuitive technology and sleek design, you can rest assured that the most targeted position can be achieved.



Pg 16
Stealth Ultra Series*



Pg 20
i2i Series



Individuals who:

- cannot maintain neutral head position due to tone, fatigue and physical deformity
- requires alternative drive controls and/or switch activation

Compatible with **DRIVE**



[*] Shown with our versatile swing-away system (page 24)



HEAD SUPPORT

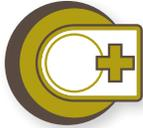

Comfort Plus Series*

Egg switch mount ESM with a black switch ESBLK page 24

920 Facial pad page 24

C53 Dartex cover page 26

CPS9-B-HW (Left & Right) swing-away hardware page 24

CP450 mounted with the TWB480 hardware with a left and right swing-away CPS9-B-HW with facial pad 920 and egg switch mount ESM with a black egg switch ESBLK

TWB480 Mounting hardware.

For more hardware options and flip down availability go to page 27.

The name says it all! When it comes to posterior head support, the Comfort Series is a must! Luxurious comfort with plush foam construction and sleek design make the Comfort Plus a favorite.

CP550 19 in (48.26 cm) **CP150** 14 in (35.56 cm) **CP250** 10 in (25.40 cm) **CP450** 8 in (20.32 cm)

CPN350 6 in (15.24 cm) **CP950** Custom
Pediatric Series

Foam Options:

1. SunMate® Foams
2. Pudgee® Foams
3. T-Foam®
4. HR1, HR2 and HR3
5. Gel

Covers Available:

1. Dartex
2. Reverse Dartex
3. Neoprene
4. Sheepskin
5. Vinyl

For more options in foams, gels and upholstery go to page 26.

Dimensions (Width x Height)	Pad Only	HMO400	HMO475	TWB480	TWB485
6" (15.24 cm) x 4.5" (11.43 cm)	CPN350	CPN300	CPN375	CPN380	CPN385
8" (20.32 cm) x 5.5" (13.97 cm)	CP450	CP400	CP475	CP480	CP485
10" (25.40 cm) x 6" (15.24 cm)	CP250	CP200	CP275	CP280	CP285
14" (35.56 cm) x 6" (15.24 cm)	CP150	CP100	CP175	CP180	CP185
19" (48.26 cm) x 6" (15.24 cm)	CP550	CP500	CP575	CP580	CP585
CUSTOM*	CP950	CP900	CP975	CP980	CP985

*Specify dimensions and angles

Durable pad constructed of layered foam on a coated metal shell and covered with a soft, durable stretch material.

All materials meet California 117 flammability standards



HEAD SUPPORT



Comfort Plus Series Specs

<p>Pediatric</p> <p>6in (15cm) 4 1/2in (11cm) 2 1/4in (6cm) 17mm Ball</p> <p>CPN350 6 in (15.24 cm) Pediatric Series</p>	<p>Small</p> <p>8in (20cm) 5 1/2in (14cm) 2 1/4in (6cm) 1in Ball</p> <p>CP450 8 in (20.32 cm)</p>	<p>Medium</p> <p>10in (25cm) 6in (15cm) 2 1/4in (6cm) 1in Ball</p> <p>CP250 10 in (25.40 cm)</p>	<p>Large</p> <p>14in (36cm) 6in (15cm) 2 1/4in (6cm) 9in (23cm) 1in Ball</p> <p>CP150 14 in (35.56 cm)</p>	<p>Extra Large</p> <p>19in (48cm) 6in (15cm) 2 1/4in (6cm) 14in (36cm) 1in Ball</p> <p>CP550 19 in (48.26 cm)</p>
--	---	--	--	---

<p>Removable Cover</p> <p>Stretchable Waterproof Antibacterial</p> <p>Washable</p> <p>Neoprene Dartex</p>	<p>Foam</p> <p>Overlaid Foam</p> <p>Removable & Replaceable</p>	<p>Adjustment</p> <p>Tilt & Rotation</p> <p>30° 360° 30°</p>
--	--	---

Durable and abrasion resistant to withstand wear and tear.

Standard 5/8 in (15.88 mm) layer of latex free closed cell rubber foam for support + 1 1/2 in (25.4 mm) of open cell polyurethane high resilience foam for comfort.

360° rotational adjustment with a positive lock ball and collar.

Machine washable.	A complete range of foams, gels, and viscoelastic materials available.	30° of tilt in all directions.
Removable and replaceable.	Hook and loop attachment for simple foam replacement.	Attached to Stealth mounting hardware, a high degree of adjustment is supplied.
Standard with Dartex (antibacterial) or Lycra® fabric (Neoprene) for pediatric.	Formed electro coated solid metal backing and rotational ball receiver.	
A complete range of custom cover solutions, colors, and styles are available.	Adhesive rubber rim binder around metal edge for protection and longevity of cover. (Only in the CP150 and CP250)	

Lateral Support

Switches

Custom Foam & Upholstery

Modifications

Highly adaptable and configurable systems.

Standard and/or custom modifications.

Removable and replaceable.

Pads, support surfaces, switches, and controls are easily added.

Foams, gels, covers, materials and shapes are available standard and custom!

Hardware designs allow the addition of lateral support surfaces with independent adjustments.

For More Modifications

Swing-Away • Page 24

Foam & Upholstery • Page 26

Mounting Hardware • Page 27



HEAD SUPPORT

30+ Tri Comfort Plus Series*

TCP450 mounted with the TWB480 hardware with right swing-away OTTOS9-R-HW with egg switch mount ESM with a red egg switch ESRED and 12" (30.48 cm) flex micro-lite switch mount (left side) CN600

12" (30.48 cm) flex micro-lite switch mount (left side) CN600 with a micro-lite switch ML210. page 24



OTTOS9-R-HW (Right) swing-away hardware page 24

TWB480 Mounting hardware

For more hardware options and flip down availability go to page 27.

Foam Available:

1. SunMate® Foams
2. Pudgee® Foams
3. T-Foam®
4. HR1, HR2 and HR3
5. Gel

Covers Available:

1. Dartex
2. Reverse Dartex
3. Neoprene
4. Sheepskin
5. Vinyl

For more options in foams, gels and upholstery go to page 29.

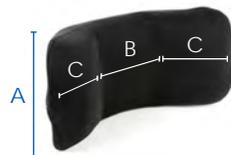

Egg Switch mount ESM with a red egg switch ESRED page 24

C51 Neoprene cover page 26

The Tri Comfort Plus Series has all of the benefits of the Comfort Plus Series in terms of comfort, luxury and style. What makes this headrest different is its three surfaces providing moderate lateral support. So don't settle for less, choose our Tri Comfort Plus and increase your level of comfort today!

TCP105
21.5 in (54.61 cm)

TCP205
16.5 in (41.91 cm)

TCP305
12.75 in (32.38 cm)

TCP405
10.75 in (27.30 cm)

TCP505
8.75 in (22.23 cm)

TCP905
Custom

Dimensions (Width x Height)	Pad Only	A	B	C
8.75" (22.23 cm) x 3.75" (9.53 cm)	TCP505	3.75" (9.53)	3.75" (9.53)	2.5" (6.35)
10.75" (27.30 cm) x 4.75" (13.97 cm)	TCP405	4.75" (12.06)	4.75" (12.06)	3" (7.62)
12.75" (32.38 cm) x 5.25" (13.34 cm)	TCP305	5.25" (13.34)	6.25" (15.88)	3.25" (8.26)
16.5" (41.91 cm) x 5.25" (13.34 cm)	TCP205	5.25" (13.34)	6.5" (16.51)	5" (12.70)
21.5" (54.61 cm) x 5.25" (13.34 cm)	TCP105	5.25" (13.34)	8" (20.32)	6.75" (17.14)
CUSTOM**	TCP905	--	--	--

** Specify dimensions and angles • Sizes shown inches (centimeters)



Durable pad constructed of layered foam on a bent coated metal shell and covered with a soft, durable stretch material.

All materials meet California 117 flammability standards

HEAD SUPPORT



Tri Comfort Plus Series Specs

Pediatric

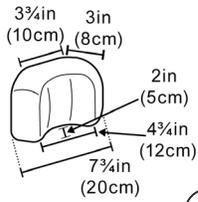

TCP505
8.75 in (22.23 cm)

Small

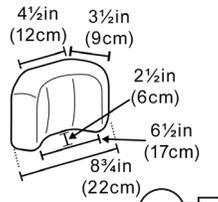

TCP405
10.75 in (27.30 cm)

Medium

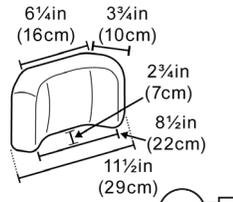

TCP305
12.75 in (32.38 cm)

Large

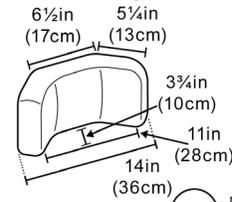

TCP205
16.5 in (41.91 cm)

Extra Large

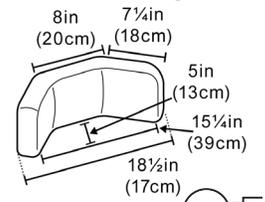

TCP105
21.5 in (54.61 cm)

Cover
Removable

Stretchable
Waterproof

Neoprene

Washable

Durable and abrasion resistant to withstand wear and tear.

Machine washable.

Removable and replaceable.

Standard with Lycra® fabric (Neoprene).

A complete range of custom cover solutions, colors, and styles are available.

Foam
Dual Layer Support

Overlaid Foam

Standard 5/8 in (15.88 mm) layer of latex free closed cell rubber foam for support + 1 1/2 in (25.4 mm) of open cell polyurethane high resilience foam for comfort.

A complete range of foams, gels, and viscoelastic materials available.

Formed electro coated solid metal backing and rotational ball receiver.

Adjustment
Tilt & Rotation

30°
30°
360°

360° rotational adjustment with a positive lock ball and collar.

30° of tilt in all directions.

Attached to Stealth mounting hardware, a high degree of adjustment is supplied.

Positioning

120°

Triple Surface Support

Lateral wings provide extra support for individuals with low or high tone.

The triple surface support helps center the head on the pad.

Increases lateral control with side wings.

Also, hardware designs allow the addition of lateral support surfaces with independent adjustments.

For More Modifications

Swing-Away • Page 24

Foam & Upholstery • Page 26

Mounting Hardware • Page 27



HEAD SUPPORT

Adjustable Comfort Plus*



ACP150 mounted with the TWB485 hardware with left and right swing-away OTTOS9-B-HW with facial pad 930 and egg switch mount ESM with a green egg switch ESGRN

930 Facial Pad
page 24

OTTOS9-B-HW
(Left & Right)
swing-away
hardware
page 24

C51
Neoprene
cover
page 26

TWB485-1
Mounting hardware

For more hardware options and flip down availability go to page 27.

Egg Switch mount ESM with green egg switch ESGRN

With two individually adjustable side pads offering 45° of angle adjustment, this headrest was designed for individuals with low tone or minimal head support. It also helps in discouraging lateral flexion for those individuals who have a tendency to hook around their head supports.



ACP150

ACP550



Dimensions (Width x Height)	Pad Only	A	B	C
13.75 (34.92) x 5.25 (13.34)	ACP550	5.25 (13.34)	6.75 (17.14)	7 (17.78)
10.25 (26.04) x 4.75 (12.06)	ACP150	4.75 (12.06)	5 (12.70)	5.25 (13.34)

Sizes shown inches (centimeters)

Foam Available:

1. SunMate® Foams
2. Pudgee® Foams
3. T-Foam®
4. HR1, HR2 and HR3
5. Gel

Covers Available:

1. Dartex
2. Reverse Dartex
3. Neoprene
4. Sheepskin
5. Vinyl

For more options in foams, gels and upholstery go to page 29.



Durable pad constructed of layered foam on 3 individually coated metal shells with bi-angular hinges and covered with a soft, durable stretch cover material.

All materials meet California 117 flammability standards

C55
Glideskin cover
page 29



HEAD SUPPORT



Adjustable Comfort Plus Specs

MEDIUM

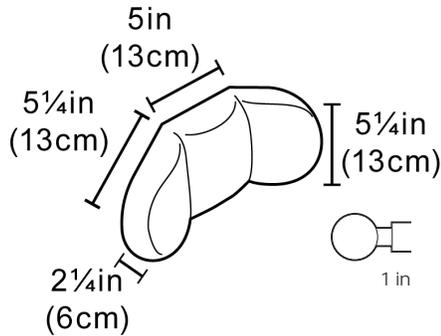

ACP150

LARGE

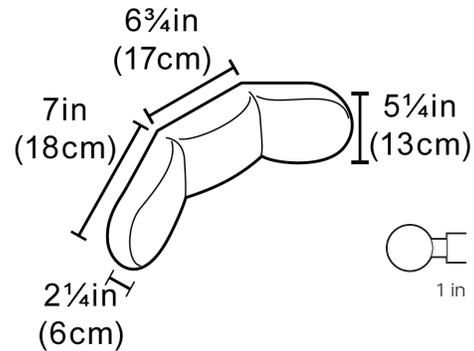

ACP550

Positioning



Adjustable Head Positioning

Cover

Removable



Washable



Stretchable
Waterproof



Neoprene

Foam



Overlaid Foam

Dual Layer Support



Side pads offer a range of independent angles to meet support and positioning needs.

Durable & Abrasion resistant to withstand wear and tear.

Standard 5/8 in (15.88 mm) layer of latex free closed cell rubber foam for support + 1 1/2 in (25.4 mm) of open cell polyurethane high resilience foam for comfort.

Discourages lateral flexion, while providing lateral support for low tone individuals.

Machine washable.

A complete range of foams, gels, and visco-elastic materials available.

45° of angle adjustment per side pad.

Standard with Lycra® Fabric (Neoprene).

Formed electro coated solid metal backing and rotational ball receiver.

A complete range of custom cover solutions, colors and styles are available.

Tilt & Rotation

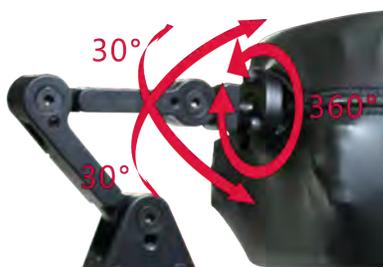

Adjustment

30° of tilt in all directions.

360° range of rotational adjustment w/ a positive lock ball and collar.

Attached to Stealth mounting hardware, a high degree of adjustment is supplied.

Modifications

Hardware designs allow the addition of lateral support surfaces with independent adjustments.

For More Modifications

Swing-Away • Page 24

Foam & Upholstery • Page 26

Mounting Hardware • Page 27



HEAD SUPPORT

Contoured Series*

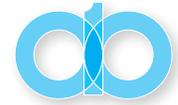

Egg switch mount ESM with a black switch ESBLK page 24

Egg switch mount ESM with a black switch ESBLK page 24

STL-OTSM250 mounted with the HMO475-1 hardware with a left and right swing-away OTTOS9-B-HW with 2 egg switch mounts ESM with two black egg switches ESBLK

OTTOS9-B-HW (Left & Right) swing-away hardware page 24

HMO475-1 Mounting hardware

For more hardware options and flip down availability go to page 27.

Whether used as a stand alone posterior head support or as part of a larger system, the Contoured Series molded headrests are ergonomically formed and valued for their robust performance and economical price.



STL-OTLG150
10 in (25.40 cm)



STL-OTSM250
9 in (22.86 cm)

Dimensions (Width x Height)	Pad Only	HMO400	HMO475	TWB480	TWB485
11.5" (29.21 cm)* x 3.5" (8.89 cm)	STL-OTSM250	STL-OTSM200	STL-OTSM275	STL-OTSM280	STL-OTSM285
12" (30.48 cm)* x 6" (15.24 cm)	STL-OTLG150	STL-OTLG100	STL-OTLG175	STL-OTLG180	STL-OTLG185

*Width Fully Extended

Durable pad constructed of layered polyurethane foam on a malleable metal shell.

All materials meet California 117 flammability standards





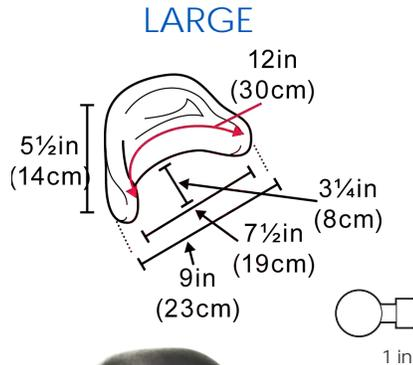

Contoured Series Specs

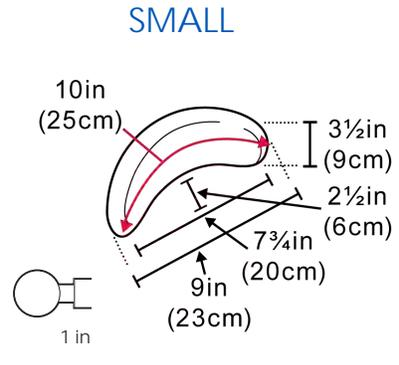

STL-OTLG150



STL-OTSM250

Positioning



Flexible and adjustable metal base allows you to form the headrest for better support.

The small contoured pad is low profile and cradles the head with basic lateral support.

The large contoured pad is a high profile pad that contains a built in occipital ledge for comfort and maximum support.

Cover

Waterproof

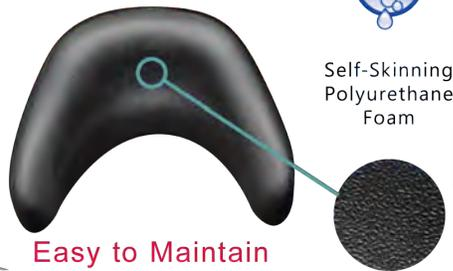

Durable and abrasion resistant to withstand wear and tear.

Wipe clean and easy to clean surface.

A complete range of custom cover solutions, colors, and styles can be added.

Adjustment

Tilt & Rotation



30° of tilt in all directions.

360° range of rotational adjustment with a positive lock ball and collar.

Attached to Stealth mounting hardware, a high degree of adjustment is supplied.

For More Modifications

- Swing-Away • Page 24
- Foam & Upholstery • Page 26
- Mounting Hardware • Page 27



HEAD SUPPORT

All Positioning Series*



Egg switch mount **ESM** with a black switch **ESBLK** page 24

Egg switch mount **ESM** with a black switch **ESBLK** page 24

SUS9-B-HW (Left & Right) swing-away hardware page 24

AP450 posterior head support mounted with the **TWB480-17FDM** hardware with a left and right swing-away **SUS9-B-HW** with 2 egg switch mounts **ESM** with two black egg switches **ESBLK**

C51 Neoprene cover page 26

TWB480-17FDM Mounting hardware

For more hardware options and flip down availability go to page 27.

When you need comfort and adjustability, depend on our All Positioning headrest. The AP Series offers a unique flexibility, constructed of malleable metal allowing a shape-on-demand quality, yet strong enough to retain its shape. When formed around the individual's head it is virtually invisible.

Foam Available:

1. SunMate® Foams
2. Pudgee® Foams
3. T-Foam®
4. HR1, HR2 and HR3
5. Gel

Covers Available:

1. Dartex
2. Reverse Dartex
3. Neoprene
4. Sheepskin
5. Vinyl

For more options in foams, gels and upholstery go to page 26.

AP150
7 in (17.78 cm)

AP250
8 in (20.32 cm)

AP350
9 in (22.86 cm)

AP450
10 in (25.40 cm)

AP550
13 in (33.02 cm)

Dimensions (Width x Height)	Pad Only	HMO400	HMO475	TWB480	TWB485
7" (17.78 cm) x 6" (15.24 cm)	AP150	AP100	AP175	AP180	AP185
8" (20.32 cm) x 6.25" (15.88 cm)	AP250	AP200	AP275	AP280	AP285
9" (22.86 cm) x 6.5" (16.51 cm)	AP350	AP300	AP375	AP380	CP185
10" (25.40 cm) x 7.5" (19.05 cm)	AP450	AP400	AP475	AP480	AP485
13" (33.02 cm) x 8" (20.32 cm)	AP550	AP500	AP575	AP580	AP585

Durable pad constructed of layered foam on a coated moldable metal shell with adhesive rubber binder and covered with a soft, durable stretch material.

All materials meet California 117 flammability standards



HEAD SUPPORT



All Positioning Series Specs

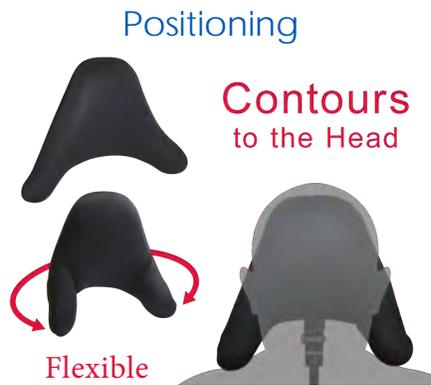
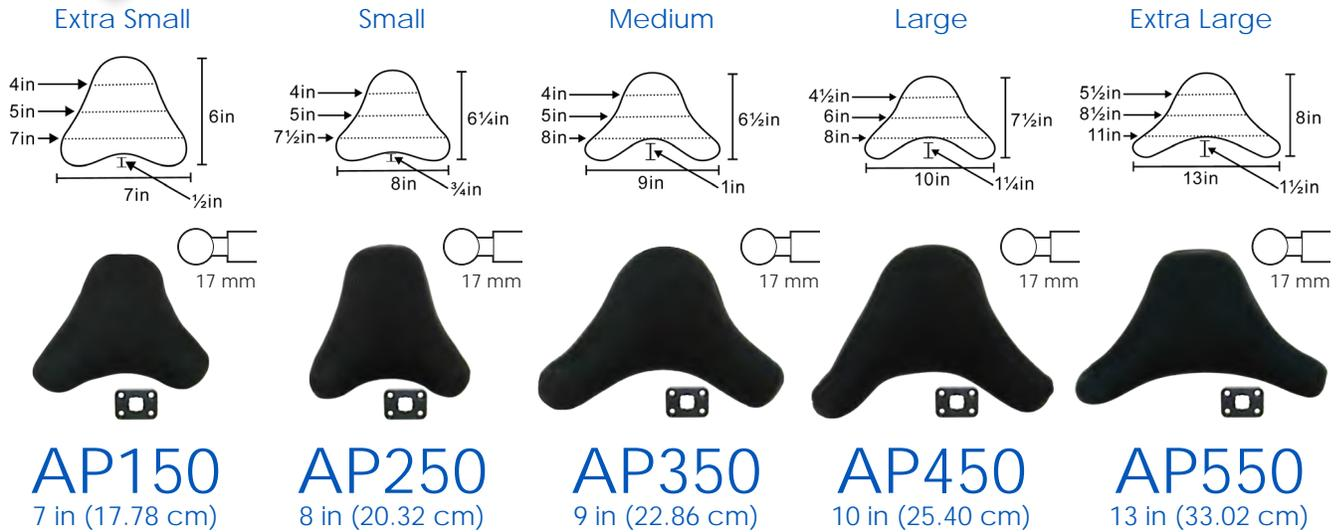

Discourages lateral flexion by improving head positioning.

Offers a soft padded support for the occiput, and malleable arms that help cradle the sub-occipital.



Durable & Abrasion resistant to withstand wear and tear.

Machine washable, removable, and replaceable.

Standard with Lycra® Fabric (Neoprene).

A complete range of custom cover solutions, colors and styles are available.

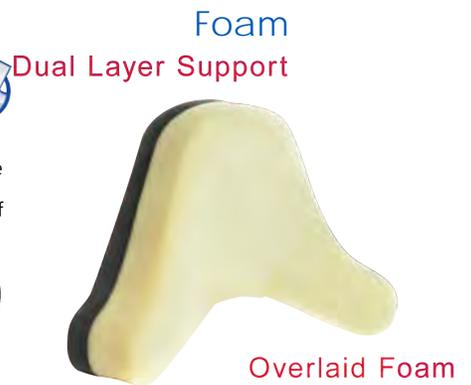

Standard 5/8 in (15.88 mm) layer of latex free closed cell rubber foam for support + 1 1/2 in (25.4 mm) of open cell polyurethane high resilience foam for comfort.

A complete range of foams, gels, and visco-elastic materials available.

Formed electro coated solid metal backing and rotational ball receiver.

Hook & Loop attachment see page 5.



Adjustment

30° of tilt in all directions.

360° range of rotational adjustment w/ a positive lock ball and collar.

Attached to Stealth mounting hardware, a high degree of adjustment is supplied.

For More Modifications

Swing-Away • Page 24

Foam & Upholstery • Page 26

Mounting Hardware • Page 27



HEAD SUPPORT

Combo Series*



900 Facial pad
page 24

SUS9-B-HW
(Left & Right)
swing-away
hardware
page 24

CB325 mounted with the HMO475-17 hardware
with a left and right swing-away SUS9-B-HW with
one egg switch mount ESM with a black egg
switches ESBLK and a 900 facial pad

C51
Neoprene cover
page 26

Egg switch mount ESM
with a black switch ESBLK
page 24

HMO475-17
Mounting Hardware

For more hardware
options and flip down
availability go to
page 27.

The Combo Series is a posterior head support that features three individual pads with adjustable wings. The lateral pads were designed to provide a wide degree of angle adjustment for optimal contact and support.

Foam Available:

1. SunMate® Foams
2. Pudgee® Foams
3. T-Foam®
4. HR1, HR2 and HR3
5. Gel

Covers Available:

1. Dartex
2. Reverse Dartex
3. Neoprene
4. Sheepskin
5. Vinyl

For more options in foams,
gels and upholstery go to
page 26.

SMALL
9.25 in (23.50 cm)†

LARGE
13 in (33.02 cm)†

X-LARGE
20.25 in (51.44 cm)†



Pad Only	Pad Height	Pad Width	Wing Width	Wing Height
CB305	5" (12.70)	3" (7.62)	3.125" (7.94)	3.75" (9.53)
CB315	5.75" (14.61)	3.5" (8.89)	4.75" (12.06)	3.5" (8.89)
CB325	6.25" (15.88)	5.75" (14.61)	7" (17.78)	6.25" (15.88)

Sizes are shown in inches and centimeters

Durable pad constructed of standard
layer of latex free closed cell rubber foam
on a coated metal shell and covered with
a soft, durable stretch material.

All materials meet California 117
flammability standards



Compatible with
DRIVE



HEAD SUPPORT



Combo Series Specs

Small

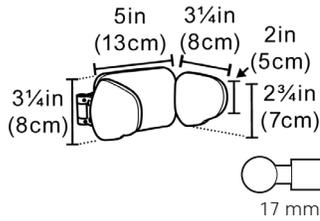

CB315

Large

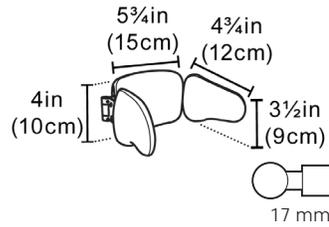

CB305

Extra Large

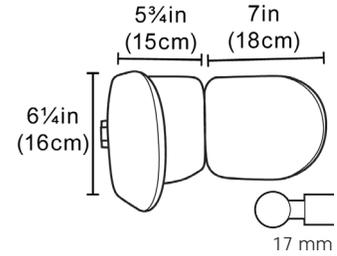

CB325

Positioning

Adjustable Lateral Support



Side pads offer a range of individually adjustable angles to meet support and positioning needs.

Discourages lateral flexion, while providing lateral support for low tone individuals.

Cover



Removable & Washable



Durable & Abrasion resistant to withstand wear and tear.

Machine washable, removable, and replaceable.

Standard with Lycra® Fabric (Neoprene).

A complete range of custom cover solutions, colors and styles are available.



Stretchable Waterproof



Neoprene

Foam



Removable & Replaceable

Overlaid Foam



Standard 5/8 in (15.88 mm) layer of latex free closed cell rubber foam for support.

A complete range of foams, gels, and visco-elastic materials available.

Formed electro coated solid metal backing and rotational ball receiver.

Hook & Loop attachment see page 5.



Tilt & Rotation

Adjustment

30° of tilt in all directions.

360° range of rotational adjustment w/ a positive lock ball and collar.

Attached to Stealth mounting hardware, a high degree of adjustment is supplied.

Modifications

Hardware designs allow the addition of lateral support surfaces with independent adjustments.

For More Modifications

Swing-Away • Page 24

Foam & Upholstery • Page 26

Mounting Hardware • Page 27



HEAD POSITIONING

Stealth Ultra Series*



500 Occipital pad

C51
Neoprene cover
page 26

SU980
Adjustable ultra channel
with 17mm horizontal bar

SUS9-B-HW
(Left & Right)
swing-away
hardware
page 24

ULTRA QCRS system includes a 500 occipital pad, a 620 sub-occipital pad, and the SUS9-B-HW swing-away system which includes the two egg switch mounts (ESM) with two black egg switches (ESBLK) mounted in the sub-occipital pad base. If not specified, by default it is mounted in the occipital pad base. The system is mounted in the Ultra QCRS channel SU980 improved in our unique link system for unlimited adjustability with the TWB480-QCRS hardware.

Egg switch mount ESM with
a black egg switch ESBLK
page 24

620 Sub-occipital pad

TWB480-QCRS
Our extraordinary TWB480
hardware adapted to fit
the Ultra QCRS channel

C51 Neoprene cover
page 26



Compatible with



Foam Available:

1. SunMate® Foams
2. T-Foams®
3. Pudgee® Foams
4. HR1, HR2 and HR3
5. Gel

Covers Available:

1. Dartex
2. Reverse Dartex
3. Neoprene
4. Sheepskin
5. Vinyl

For more options in foams, gels and upholstery go to page 26.

The "Ultra" head positioning system was the first product Stealth designed. Its advanced technology continues to evolve from the Ultra, to the Ultra QCR and now the Ultra QCRS; pioneering the new standard of head positioning.

The Ultra recognized that every posterior head support needs to be as individualized as the person requiring it. Finally support pads / switch sides / alternative drive controls were able to be added in a quick, clean, reliable and simple way. The Ultra QCRS upgrade featured a center channel link that enabled independent depth adjustment for both the occipital and sub-occipital supports.

With the addition of the SU980, you can transform any of Stealth Products head positioning systems into an "Ultra" configuration.

Available in
Standard or **Pediatric** sizes



Building an Ultra

The Ultra QCRS is an all encompassing head positioning system with adjustment capabilities and a host of options/accessories to meet virtually requirement.

Now follow 5 easy steps and you are done!

Step 1: Choosing an Occipital Pad (**)



Occipital Pad

The occipital pad cradles the head and is primarily a resting spot with nominal lateral support, although it also acts as a posterior boundary minimizing hyper-extension from abnormal reflexes or tone. The occipital pad is necessary for transportation as well as tilt and recline features.

Ultra Large 500 Pad

6" L x 3.75" H
(15.24 cm x 9.53 cm)

Ultra Small 510 Pad

4.5" L x 2" H
(11.43 cm x 5.08 cm)

Ultra Niño 520 Pad

3" L x 3" H
(7.62 cm x 7.62 cm)

Ultra Niño 530 Pad

3" L x 2" H
(7.62 cm x 5.08 cm)

CPN350

6" L x 4.5" H
(15.24 cm x 11.43 cm)

Step 2: Swing-Away Hardware (Optional) See page 24

Step 3: Ultra QCRS Channel Link (**)



SU980

Step 4: Sub-Occipital Pad (**)

Positioned at the base of the skull, and used in conjunction with an occipital pad, the sub-occipital pad provides additional lateral and posterior support for individuals that require mild to moderate assistance in maintaining midline positioning. The sub-occipital is malleable, so it can be contoured specifically for each individual, which alleviates the tendency to suspend the head or create excessive pressure on the neck.



600

8.5" L x 2.75" H
(21.59 cm x 6.99 cm)

610

6.375" L x 2.25" H
(16.19 cm x 5.71 cm)

620

10.5" L x 2.75" H
(26.67 cm x 6.99 cm)

Step 5: Mounting Hardware (See page 27)



TWB480-QCRS

TWB480-QFDM

Flip Down



SEE MORE



FDM350

Flip down mount
1/2" square
tubing

Use the power of the i2i Series in your Ultra



Style	Part #	MSRP
Small Low Profile	i2i455	\$325
Small Low Profile Short Arms	i2i456	\$325
Medium Low Profile	i2i555	\$325
Medium Low Profile Short Arms	i2i556	\$325
Large Low Profile	i2i655	\$400
Large Low Profile Short Arms	i2i656	\$400
X-Large Low Profile	i2i755	\$400
X-Large Low Profile Short Arms	i2i756	\$400

More information in the i2i Series section

Default pad's foam and upholstery



C51

Neoprene Black

Standard

Closed Cell Foam

Extremely wide range of upholstery and foam options. Go to page 26 for more.



HEAD POSITIONING



Clinical Guidelines

This clinical guideline should be used as a general reference for product applications. Final decisions regarding size, material, foam, and gel placement should be left to qualified professionals who are familiar with the

individual's specific needs through evaluation and/or trial and observation. The Ultra comes with an occipital pad, ultra channel, sub-occipital pad, and optional facial lateral pads and switches - see below.

How it Works?

The occipital pad cradles the head and is primarily a resting spot with nominal lateral support, although it also acts as a posterior boundary minimizing hyper extension from abnormal reflexes or tone. The occipital pad is necessary for transportation as well as tilt and recline features.

Facial lateral pads are preferable for individuals with considerable uncontrolled movement such as seizures, reflexes, or individuals with low tone or cognition. Facial pads can be used to facilitate proper head alignment and deter further deformity or shortening of muscles.

Independent adaptability for the occipital and the sub-occipital pads provided by the SU980 hardware with one tool set up.



Positioned at the base of the skull, and used in conjunction with an occipital pad, the sub-occipital pad provides additional lateral and posterior support for individuals that require mild to moderate assistance in maintaining midline positioning. The sub-occipital is malleable, so it can be contoured specifically for each individual, which alleviates the tendency to suspend the head or create excessive pressure on the neck. Sub-occipital pads are engineered with Memory Metal that contours to an individual's specific shape without losing strength. This pad should not touch the individual's mandible.

Facial switches are both practical and easily accessible. When embedded in a facial pad they become a discreet and supportive switch access point. Facial switches are also valuable in maintaining muscle strength or developing good head alignment.

Maximizing Effectiveness With The i2i

Individuals who require substantial support and positioning, have minimal head control, or hook around their headrest may consider the Ultra used in conjunction with a low profile i2i and chin prompt. This system is a complete therapeutic tool offering posterior, lateral, and anterior support. The Chin Prompt will be more beneficial than facial pads for individuals developing active head control because it is easily raised and lowered as needed throughout the day.

The i2i Ultra can be further customized with swing-away facial pads and switches. Swing-Away lateral facial pads can enhance alignment or provide additional support during fatigue. Also, facial switches are highly accessible and can be used therapeutically to encourage further development of active head movement.





What makes the SU the best?

The Ultra QCRS has been enhanced with our unique link system that makes this system the most effective and versatile head positioning system on the market. With its

one tool setup design, setup and adjustments are quick and easy. For the most challenging situations you may encounter, consider using the i2i to maximize effectiveness.



Shown Systems Set Up

Top system packed with a 500 occipital pad and a 620 sub-occipital pad, with the SUS9-B-HW swing-away system including one egg switch mount (ESM) with a black egg switch (ESBLK), and a 900 facial pad mounted in the sub-occipital pad base, if not specified, by default is mounted in the occipital pad base. The system is mounted with the Ultra QCRS channel SU980, and improved with our unique link system for unlimited adjustability with the TWB480-QCRS hardware. Pad covers upholstered with the standard C51 black neoprene. The bottom system has a I2I450 as a sub-occipital pad with a TD100 tone deflector and I2I460 chin prompt, 500 occipital pad with ultra channel, and TWB480-QFDM hardware.

For more information about our Ultra QCRS visit our website or scan this QR code with your smartphone or tablet





HEAD POSITIONING

i2i Series



Layered latex free closed cell rubber foam on a coated metal shell and covered with a soft, durable stretch material.

All materials meet California 117 flammability standards

TD100
Tone Deflector
page 27

C55
Neoprene Glideskin cover
page 26

TWB480-17FDM
TWB Link Hardware 17 mm
ball kit with easy release
flip down mechanism.
Required hardware for
the i2i Series.

I21480 is a standard package that includes the i2i small pad I21450, one I21460 small chin prompt and the TWB480-17FDM hardware. This package shown two upgrades, the TD100 tone deflector to protect the hardware from tone impacts.

I21460
Small chin prompt



The i2i has been one of Stealth's signature products and one that is recognized around the world. The i2i head, neck, and shoulder positioning system is offered in eleven different series. We have made significant improvements through the years and now have added a few more. (Please refer to www.stealthproducts.com for more information)



Compatible with





Why it works?

Head and neck positioning is one of the most difficult challenges we face. The i2i system was developed by Leslie Fitzsimmons PT, ATP, who after trying all available options, decided that enough was enough and designed the i2i system for the most challenging students at Lakeview School in New Jersey. The unique, integrated form (shape) of the i2i connects the head, neck and

shoulders, and forms a support similar to that of an exoskeleton. Unlike many collar type devices, the i2i does not position low on the neck which tends to leave the upper neck and head unsupported. The anterior arms of the i2i act as an anchor for the chin prompt, provides an anterior thoracic boundary, and creates a channel to direct extensor tone into a midline position. The lateral component

promotes midline head position and offers cervical support while maintaining range of motion (ROM). As an individual begins to extend, their head is invited back into a more neutral position. A midline position discourages reflex postures and provides appropriate proprioceptive input. It has also been found to promote the development of controlled neck flexion and extension.

i2i Available Sizes



Features & Add ons



Adjustable Arms

Designed to pivot anterior arms laterally to aid in removal and placement of i2i. Also, it allows unique positioning and flexion with a locking mechanism to keep your adjustments in place.

TD100 Tone Deflector

The tone deflector is a headrest add-on that deflects the pressure of high tone away from the hardware, letting your settings stand over the test of time.



Real Results!



Default pad's foam and upholstery



Extremely wide range of upholstery and foam options. Go to page 26 for more.



HEAD POSITIONING

i2i Overview



Unique Shape

The unique, integrated shape of the i2i provides a maximal, proximal foundational connection between the head and neck. The sub-occipital and integrated low profile occipital components provide posterior support and set a limit to cervical extension while also offering a resting spot.

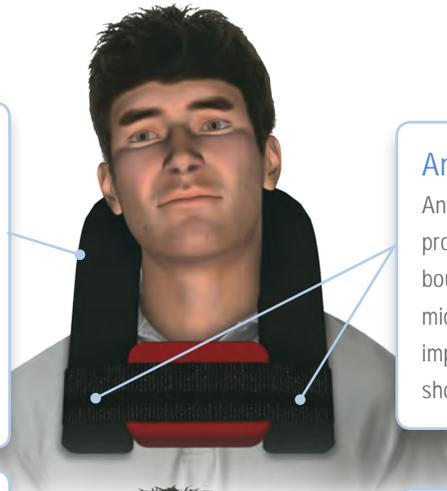

Anterior Arms

Anterior arms act as an anchor for the chin prompt and provide an anterior thoracic boundary that channels movement into a midline position. With children, it is especially important the anterior arms don't obstruct shoulder movement.

Lateral Components

The lateral component promotes midline head position and offers cervical support while maintaining range of motion (ROM). Individuals with excessive weakness and poor head control should choose a more intimate fit, while individuals with more controlled movement may choose a looser fit. It is recommended for proper i2i fitting to have at least a 1/4" to 1/2" spacing between the individual's neck and i2i.

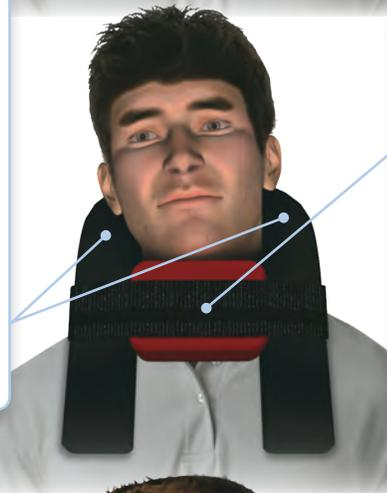

Chin Prompt

The chin prompt is a dynamic support that provides foundational anterior head positioning. When systematically raised and lowered, it is an excellent therapeutic tool that encourages neck muscle strengthening. The chin prompt was carefully crafted and engineered with a curved posterior that prevents airway obstruction and a width that prevents an individual's chin from rolling over the front. Additionally, the prompt is made with a closed cell foam that prevents sinking, and the straps are designed to slide if too much pressure is exerted.

A variation of the chin prompt is also offered that is specifically designed for the trachea. For safety, the chin prompt should only be used under a caregiver's supervision, and is **NOT** to be used during transportation.

Customized Frame

With the redesigned i2i standard frame you will be able to adjust and cut the foam to fit your individual's specifications even if no ear cutouts were specified.

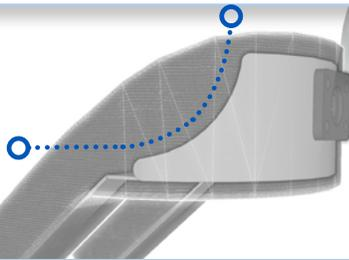

Ear Cutouts

Individuals with excessive lateral flexion should consider ear cutouts on the i2i. The cutouts are specifically designed to increase ROM while reducing excessive lateral flexion and rooting reflexes. Also, ear cutouts should lessen friction and pressure for those with severe lateral flexion thereby reducing irritation and deformity.

Adjustable Arms and Locking Mechanism

The i2i can now be equipped with adjustable arms that allow for easy removal and placement of i2i as well as offer unique positioning and flexion. The locking mechanism allows you to keep your adjustments in place.



HEAD POSITIONING



How to measure

Note if...

- You need foam build-up or removal
- You want gel padding on selected areas (other than shown standard)
- You need custom arm length
- You need adjustable arms or gel insert

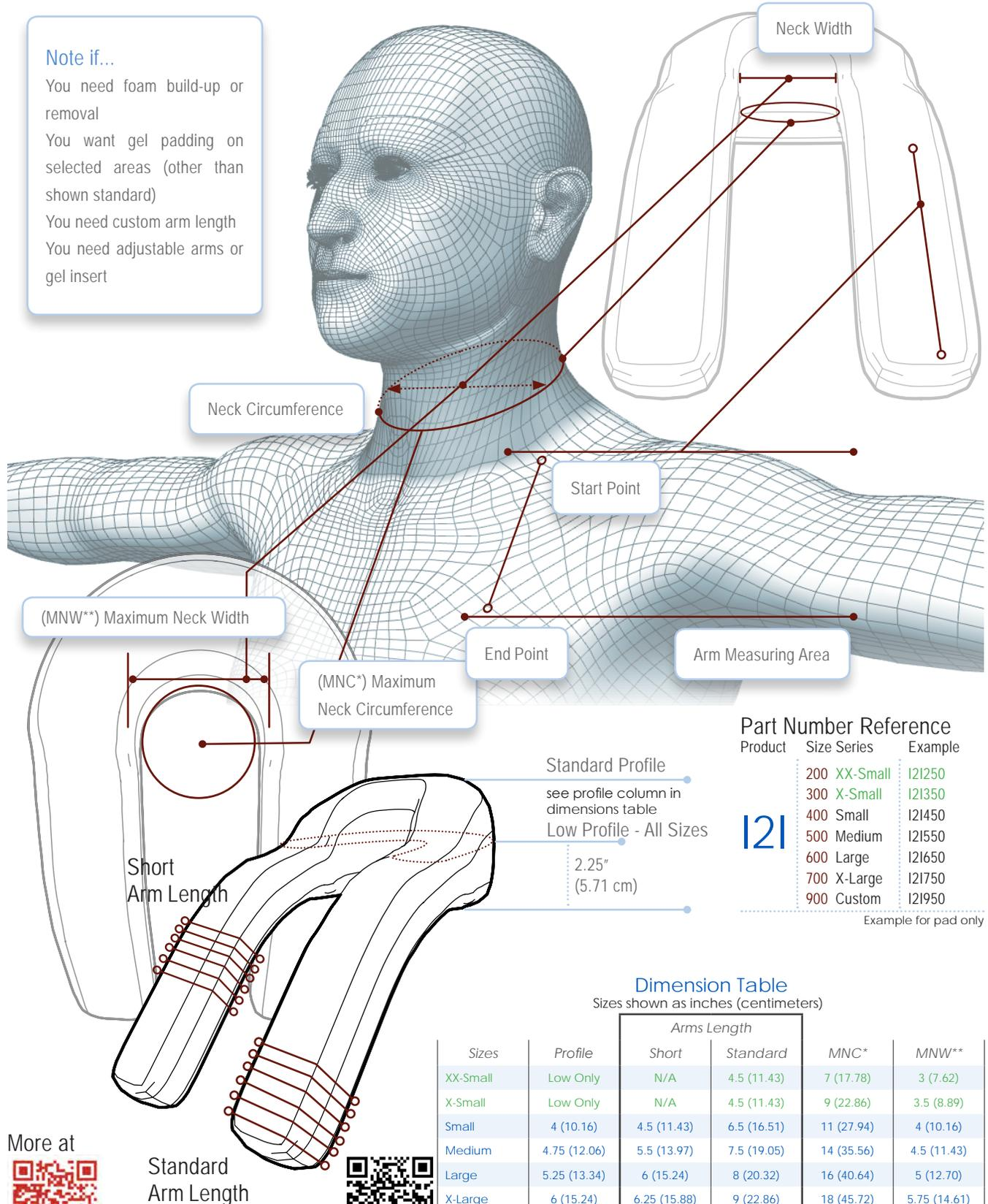

Part Number Reference

Product	Size Series	Example
200	XX-Small	I2I250
300	X-Small	I2I350
400	Small	I2I450
500	Medium	I2I550
600	Large	I2I650
700	X-Large	I2I750
900	Custom	I2I950

I2I

Example for pad only

Dimension Table

Sizes shown as inches (centimeters)

Sizes	Profile	Arms Length		MNC*	MNW**
		Short	Standard		
XX-Small	Low Only	N/A	4.5 (11.43)	7 (17.78)	3 (7.62)
X-Small	Low Only	N/A	4.5 (11.43)	9 (22.86)	3.5 (8.89)
Small	4 (10.16)	4.5 (11.43)	6.5 (16.51)	11 (27.94)	4 (10.16)
Medium	4.75 (12.06)	5.5 (13.97)	7.5 (19.05)	14 (35.56)	4.5 (11.43)
Large	5.25 (13.34)	6 (15.24)	8 (20.32)	16 (40.64)	5 (12.70)
X-Large	6 (15.24)	6.25 (15.88)	9 (22.86)	18 (45.72)	5.75 (14.61)

More at



Standard Arm Length



Scan or click to download brochure



SWING-AWAY SYSTEMS



With the addition of Stealth's swing-away hardware, you can upgrade a simple posterior head support into a head positioning system. Stealth's swing-away hardware is designed to be reliable, lightweight, clean, and discreet so that the hardware blends in with its surrounding so "you see the person, not the hardware!" It features an easy one-hand release mechanism enabling pads and switches to swing away back 100°, and just as easily return to their original position. This convenient feature is useful for transfers, therapy, and fatigue issues. It's no wonder why Stealth Products has moved to the "HEAD OF THE CLASS."

Swing-Away Hardware

SUS9 Series



SUS9-B-HW

Swing-away with left and right ears with standard 9" (26.86 cm) rods.

Compatible with:
AP, CB, i2i, and SU Series

SUNS9 Series



SUNS9-B-HW

Pediatric swing-away with left and right ears with standard 6" (15.24 cm) rods.

Compatible with:
CPN350 and SUN Series

CPS9 Series



CPS9-B-HW

Swing-away with left and right ears with standard 9" (26.86 cm) rods.

Compatible with:
CP Series

OTTOS9 Series



OTTOS9-B-HW

Swing-away with left and right ears with standard 9" (26.86 cm) rods.

Compatible with:
OB and TCP Series

See more of our swing-away systems at www.stealthproducts.com

Rod Sizes



SU262
6" (15.24 cm)
bendable rod

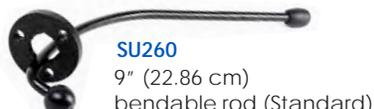

SU260
9" (22.86 cm)
bendable rod (Standard)



SU264
13" (33.02 cm) bendable rod



SU265
18" (45.72 cm) bendable rod

SU266
24" (60.96 cm) bendable rod

Rods can be cut to desired size with bolt cutters or a hacksaw. Rod caps slip over cut ends. Can be straightened, or bent, to customize. **Warning!** Repeated bending will result in breakage.

Facial Pads



910 Pad
3" L x 2" H
(7.62 cm x 5.08 cm)



900 Pad
4.5" L x 2" H
(11.43 cm x 5.08 cm)



920 Pad
6.375" L x 2.25" H
(16.19 cm x 5.71 cm)



C51
Neoprene black



Standard
Closed cell foam

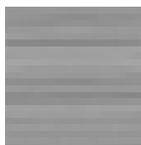

Standard
Aluminum base



930 Pad
6.375" L x 1.5" H
(16.19 cm x 3.81 cm)

Switch Mounts



ESM - Egg Switch Mount
1.75" L x 1.25" H
(4.45 cm x 3.17 cm)



CN600
12" (30.48 cm) Flex micro-lite
switch mount
CN600-B Both Sides



SP625
Sip & Puff mount for swing-
away systems



SSM-100
Spec-Switch
mount

SWING-AWAY OPTIONS



Swing-Away Layout Options



There is no limit on what you can accomplish with our swing-away systems! Regardless of the individual's needs, capabilities or motor functions, a swing-away system can be used to

position any pad, switch, or control wherever it is most beneficial. For more information call us or visit our website.

Joystick Mounts



SM600
Mini proportional joystick mount with rod



SM610
1812 Joystick mount



SM670
I-drive precision mini proportional joystick mount

Compatible with
i-Drive



F8675-RING-CN
Flex tubing figure 8 specially designed for the i-Drive®



ABOUT SWITCHES



SENSORS

STEALTH'S ALTERNATIVE
DRIVE CONTROL SYSTEM

FOR MORE SWING-AWAY OPTIONS VISIT US AT STEALTHPRODUCTS.COM





FOAM AND UPHOLSTERY

FOAMS & GELS

HR (HIGH RESILIENCE)			SUNMATE®				PUDGEE	Foam Thickness Increments	
HR1	HR2	HR3	X-SOFT	SOFT	MEDIUM	FIRM	HR Foams		1/2 in (1.27 cm) / 1 in (2.54 cm)
T-FOAM®			GEL		STRUCTURAL		Pudgee®		1/2 in (1.27 cm) / 1 in (2.54 cm)
X-SOFT	MEDIUM	FIRM	FLAT	WAFFLE	ETHA FOAM	CLOSED CELL	T-Foam		1/2 in (1.27 cm) / 1 in (2.54 cm)
							SunMate®		1/2 in (1.27 cm) / 1 in (2.54 cm)
							Gel	1/2 in (1.27 cm)	

VINYL

CARBON FIBER					BISCAYNE						
C04	C05	C06	C07	C08	C24	C25	C26	C28	C29	C30	C31
C09	C10	C11	C12	C16	C32	C33	C34	C35	C36	C37	C38
C13	C14	C15	C73	C39	C40	C41	C42	C43	C44	C45	
BRUSHED ALUMINUM					SPARKLE						
C01	C02	C03	C71	C72	C74	C78	C79	C80	C81	C82	C83
CRACKLE											
					C84 C85						

NEOPRENE

C17	C18	C19	C20
C21	C22	C23	C51
C60	C61	C62	C63
C87			

ALSO AVAILABLE

GLIDESKIN	TEK STRETCH
C55	C94 C95
AIR FLOW MESH	CORDURA
C86 C96	C56
DARLEX	DARTEX
C54	C52 C53
SHEEPSKIN	
C88 C89 C90	

Upholstery Properties

Upholstery Style	anti-microbial	breathable	stretchable	waterproof	water resistant
Air Flow Mesh	•	•	•	•	•
Brushed Aluminum	•				•
Carbon Fiber	•	•	•		•
Cordura					
Darlex		•	•	•	
Dartex		•	•	•	
Tek Stretch			•	•	•
Neoprene			•	•	•
Glideskin			•	•	•
Vinyl / Naugahyde	•				•

See samples online



MOUNTING HARDWARE



Hardware is an essential tool for getting a carefully considered headrest into the correct position. Stealth carries a variety of options to help achieve your positioning goals. Whether you need hardware with high or minimal adjustment, we have you covered!

Straight Hardware



NOTE Extreme durability, securely locking adjustment points and universal seat back mounts are standard on all hardware.

Extras

FLIP DOWN

FDM350
Flip down mount
(1/2" square tubing)



TONE DEFLECTOR

The Tone Deflector serves two main functions: *Absorb* and *Avert*. This intuitive design will absorb quick impact compression and avert slanted angle loading. The Tone Deflector (TD) will be the premier addition for any high tone situation.



TD100
17 mm Ball



TD101
1" Ball

Link Style Hardware





STEALTH PRODUCTS, INC.
BEYOND EXPECTATION

© 1999-2015

1.800.965.9229 | fax 1.800.806.1225

info@stealthproducts.com

www.stealthproducts.com

104 John Kelly Drive, Burnet TX 78611

